

**COOL PLANET STANDARD ARCHITECTURAL CANOPY**  
**- FLAT MARQUEE STYLE**  
**- LOUVER CANOPY - 8" FASCIA**

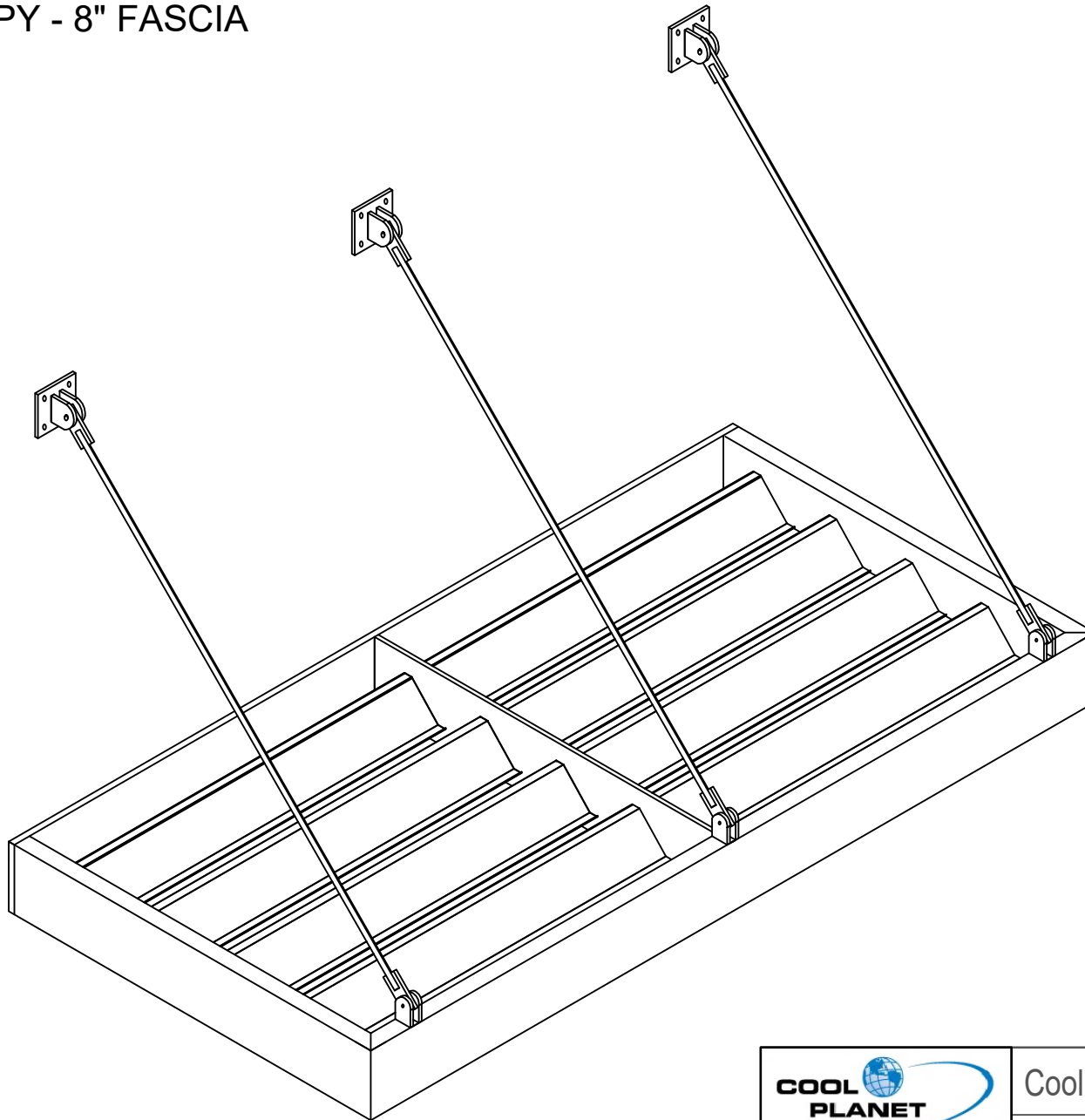

340 S. Mitthoeffer Rd. • Indianapolis, IN 46229  
 P (317) 927-9000 • F (317) 927-9003  
 www.coolplanetawnings.com

Cool Planet Awning Company

Louver Canopy

DRAWN BY	APPROVED BY	DATE
DRAWING NO.	REVISION DATE	SCALE
		5/8" = 1'-0" C1

1/C2

# TRANSVERSE SECTION

Scale: 1"=1'

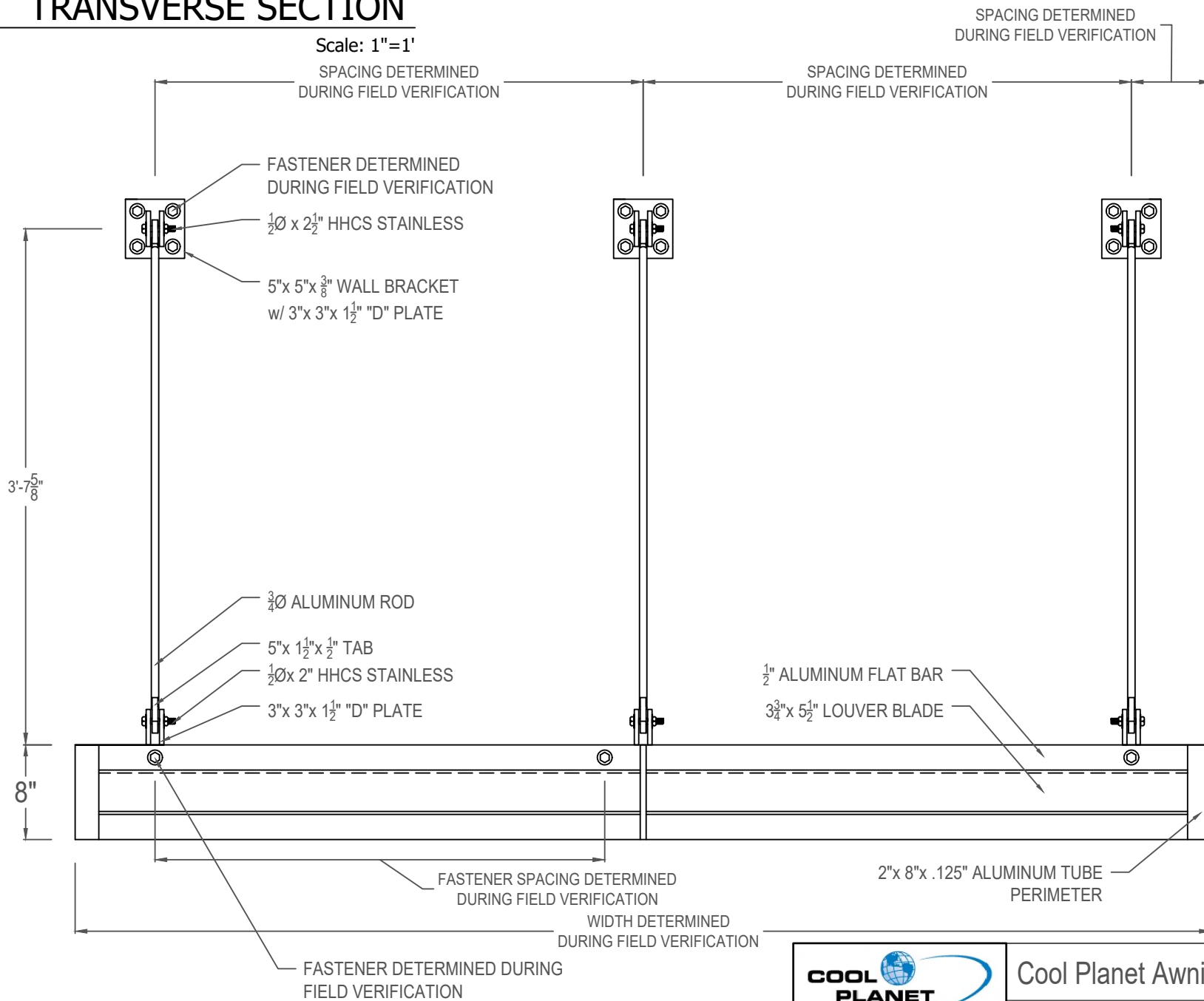

Cool Planet Awning Company

## Louver Canopy

340 S. Mitthoeffer Rd. • Indianapolis, IN 46229  
 P (317) 927-9000 • F (317) 927-9003  
 www.coolplanetawnings.com

DRAWN BY	APPROVED BY	DATE
REVISION DATE	SCALE	SHEET
	noted	C2

2/C3

# TRANSVERSE SECTION

Scale: 1"=1'

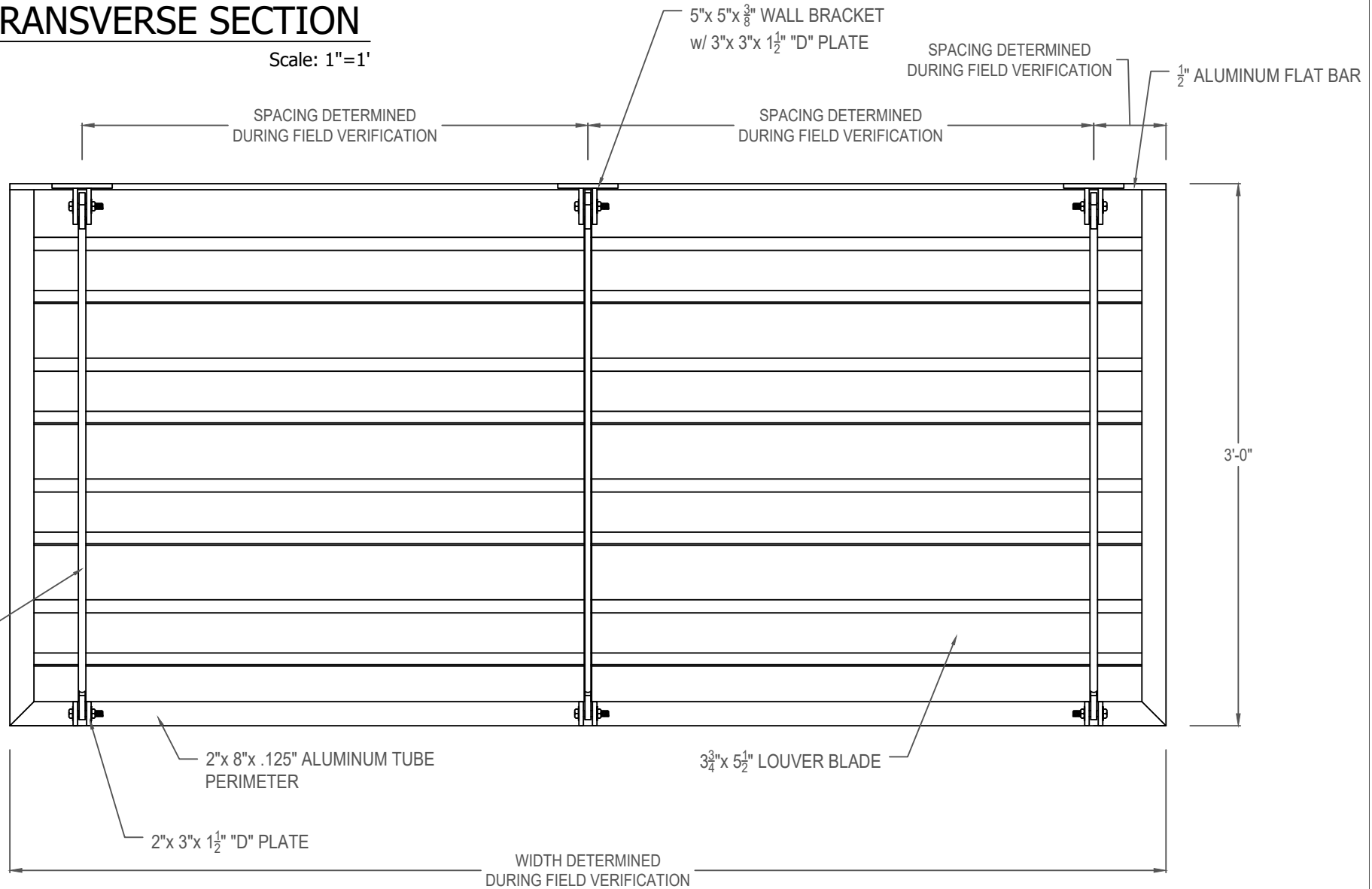

Cool Planet Awning Company

## Louver Canopy

340 S. Mitthoeffer Rd. • Indianapolis, IN 46229  
 P (317) 927-9000 • F (317) 927-9003  
 www.coolplanetawnings.com

DRAWN BY	APPROVED BY	DATE
----------	-------------	------

DRAWING NO.	REVISION DATE	SCALE	SHEET
		noted	C3

# 3/C4 SECTION - RETURN / LOUVER

Scale: 1-1/8"=1'

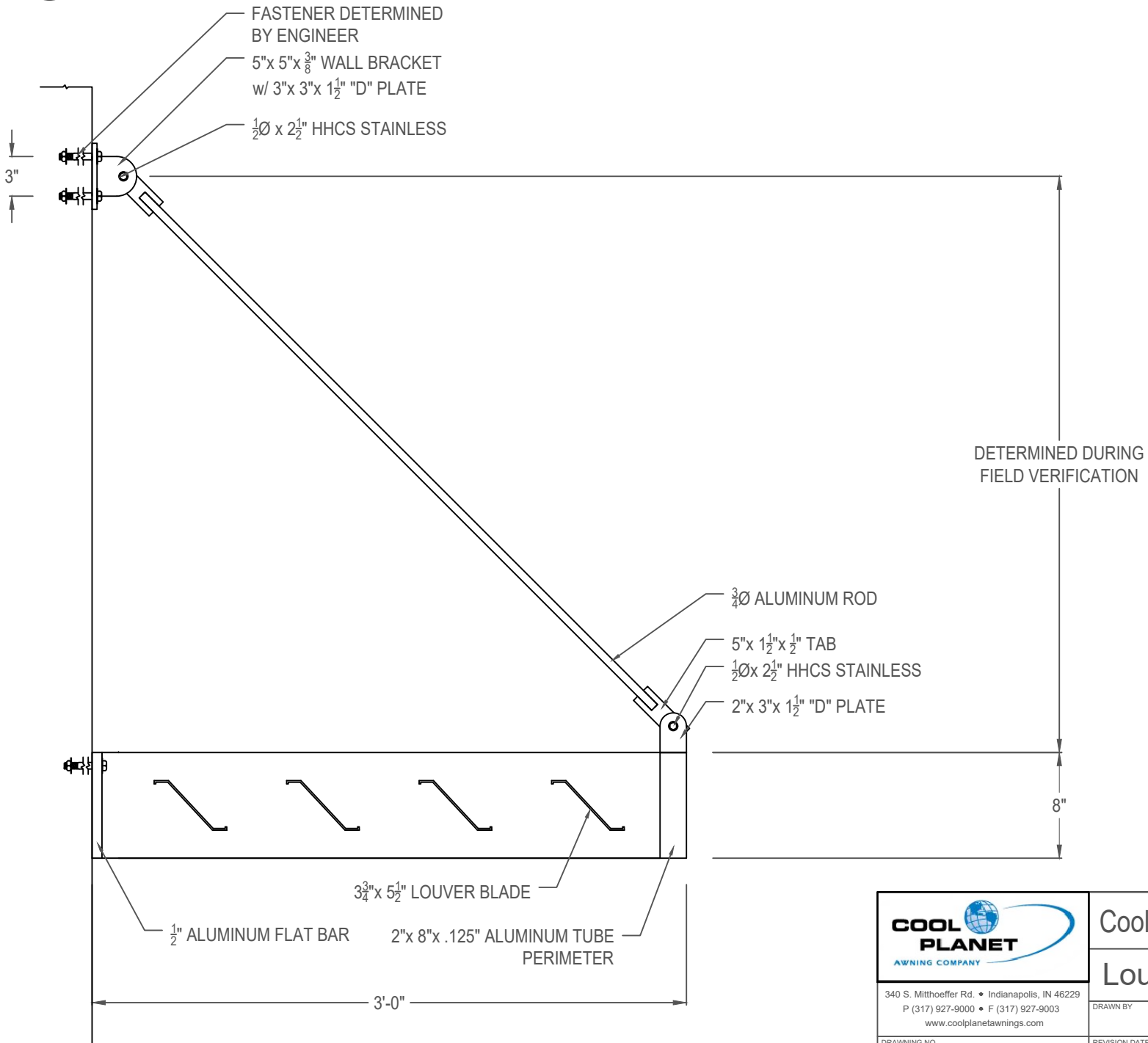

Cool Planet Awning Company

Louver Canopy

340 S. Mitthoeffer Rd. • Indianapolis, IN 46229  
 P (317) 927-9000 • F (317) 927-9003  
 www.coolplanetawnings.com

DRAWN BY	APPROVED BY	DATE
REVISION DATE	SCALE	SHEET
	noted	C4

4/C5

# RETURN ARM & BRACKET

Scale: 2"=1'

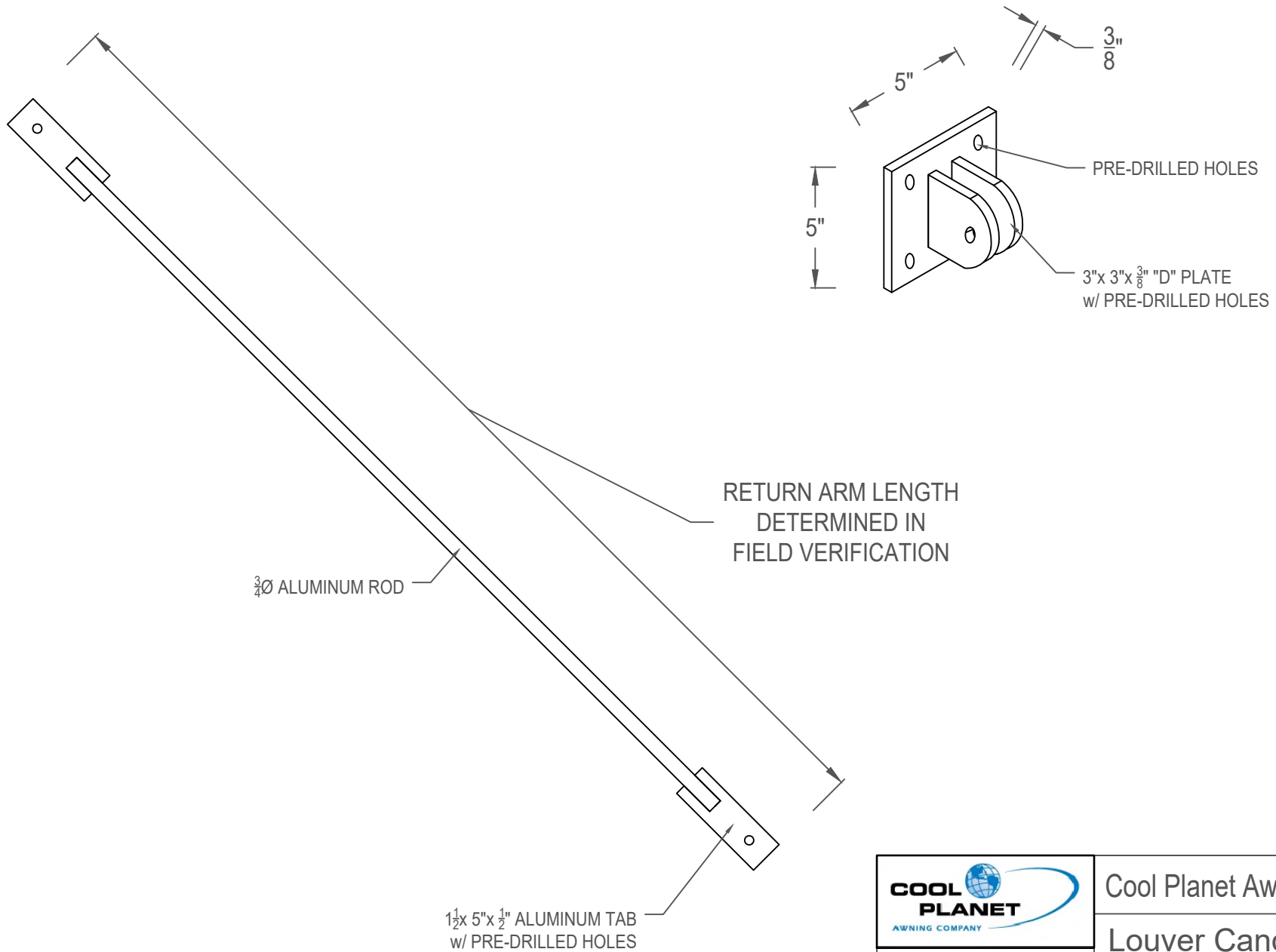

Cool Planet Awning Company

Louver Canopy

340 S. Mitthoeffer Rd. • Indianapolis, IN 46229  
P (317) 927-9000 • F (317) 927-9003  
www.coolplanetawnings.com

DRAWN BY	APPROVED BY	DATE
REVISION DATE	SCALE	SHEET
	noted	C5

5/C6

# MATERIAL LIST

Scale: 3"=1'

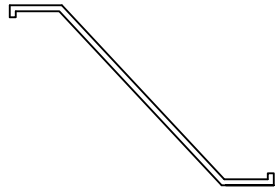

3-3/4" x 5-1/2" x .065" SELF MATING CANOPY ROOF PAN - 6063-T6



2" x 8" x .125" ALUMINUM TUBE - 6063-T52

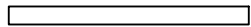

3/8" x 8" x ALUMINUM BAR - 6061-T6511

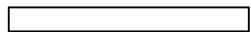

1/2" x 8" x . ALUMINUM BAR - 6061-T6511

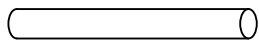

3/4Ø ALUMINUM ROD - 6061-T6511

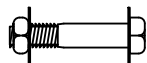

1/2Ø x 2-1/2" HEX HEAD CAP SCREW - STAINLESS



340 S. Mitthoeffer Rd. • Indianapolis, IN 46229  
P (317) 927-9000 • F (317) 927-9003  
www.coolplanetawnings.com

Cool Planet Awning Company

## Louver Canopy

DRAWING NO.	REVISION DATE	SCALE noted	SHEET C6
-------------	---------------	----------------	-------------

6/C7

# PERIMETER ADD-ONS

Scale: 1-1/2"=1'

## CUSTOM - FORMED "C" CHANNEL PERIMETER

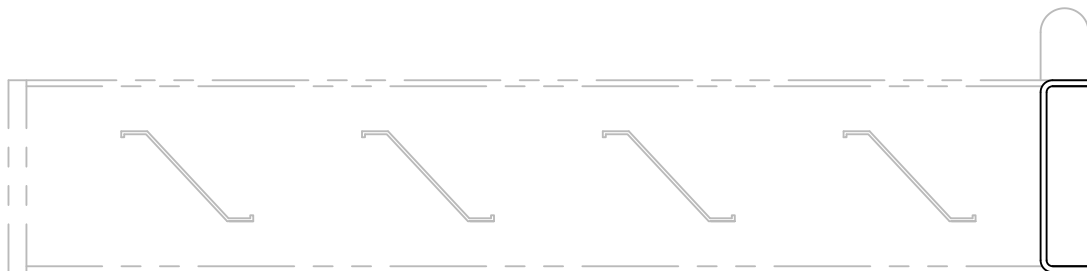

NOTE:  
"C" CHANNEL SIZE SPEC. PER APPLICATION

## FLAT ALUMINUM PERIMETER

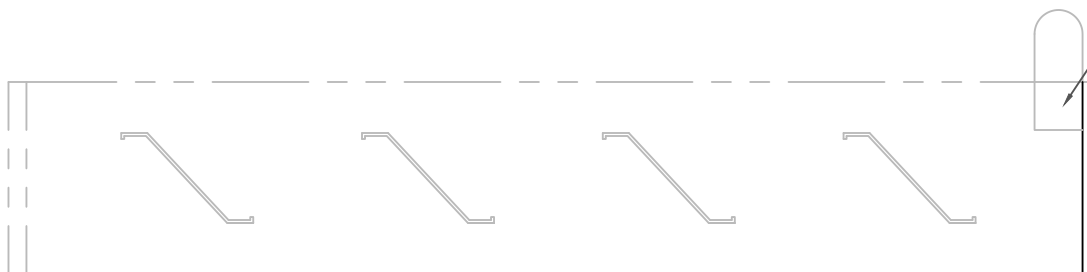

LONGER TAB TO MOUNT TO SIDE  
OF PERIMETER

NOTE:  
FLAT ALUMINUM SIZE SPEC. PER APPLICATION

 340 S. Mitthoeffer Rd. • Indianapolis, IN 46229 P (317) 927-9000 • F (317) 927-9003 www.coolplanetawnings.com	Cool Planet Awning Company		
	Louver Canopy		
DRAWN BY	APPROVED BY	DATE	
DRAWING NO.	REVISION DATE	SCALE noted	SHEET C7